

## Specifications

備注 (Remark)

1. 材料 (Material)

膠芯: PA9T/LCP+30%G.F UL94V-0, 顏色: 黑色

Housing: PA9T/LCP+30%G.F UL94V-0, Color: Black

端子: 黃銅

Contact: Brass

2. 特性 (characteristics):

額定電流: 1.00AMP

Rating Current: 1.00AMP

接觸阻抗: 20mΩ Max

Contact Resistance: 20mΩ Max

絕緣阻抗: 1000MΩ Min

Insulating Resistance: 1000 MΩ Min

耐電壓: AC 500V/分鐘

Withstanding Voltage: AC 500V/Minute

溫度範圍: -40° C to +105° C

Temperature Range: -40° C to +105° C

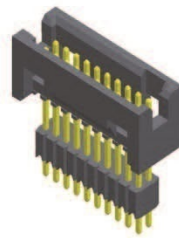

B127-25PXXXXXX1

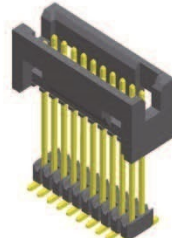

B127-25SXXXXXX1

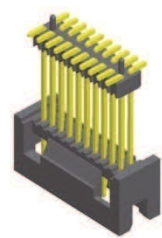

B127-25SXXXXXX2

Mating With/配對母座:

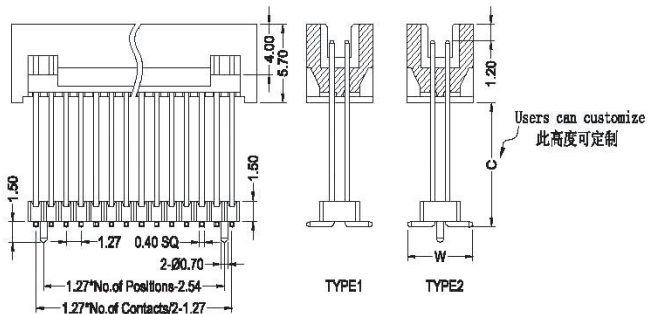
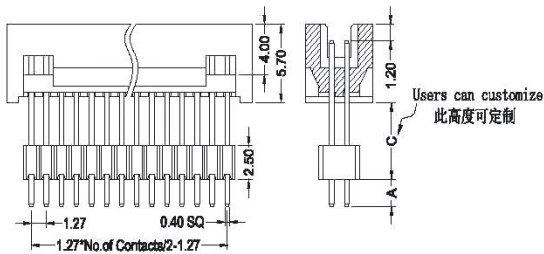
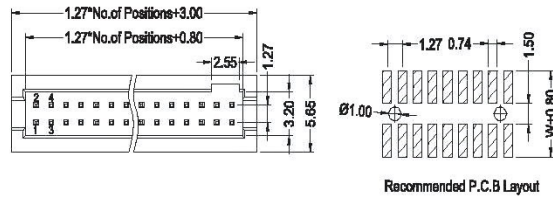
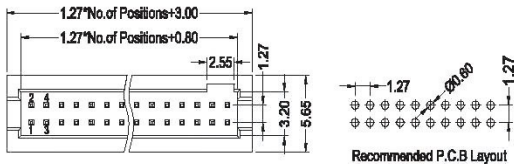
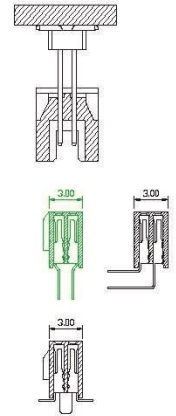

Dimension antitheses list		
ITEM	Dim A	Dim C
Standard	2.50	
Alternate		

Dimension antitheses list		
ITEM	Dim C	Dim W
Standard		5.50
Alternate		

BOX HEADER B

**B127-25**

**X**

**Contact Shape:**  
P: Straight  
S: SMT

**XX**

**No.Of Pins**  
04~100P

**XX**

**Contact Plating**  
Full Of Gold  
G0=0.8u"  
~  
G9=30u"  
S1=Ordinary Tin Plated  
S2=Matte Tin Plated  
S3=Tin-plated High-temperature

**X**

**Insulator Colour**  
B: Black  
G: Grey

**X**

**Packing**  
A: PE Bag  
R: Tape & Reel  
T: Tube  
D: Tube+CAP  
E: Tray

**X**

**Journal Number**  
1: Type1 (without Post)  
2: Type2 (with Post)